

RECESSED STILE

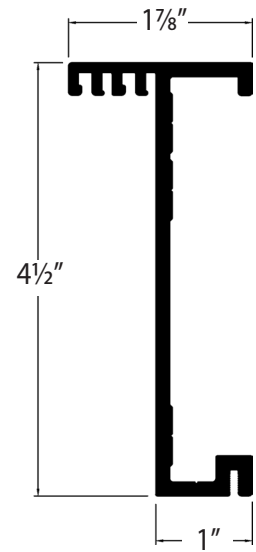

JAMB

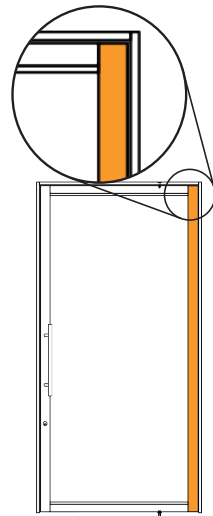
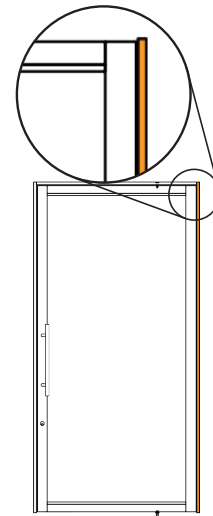

TOP PIVOT PIN

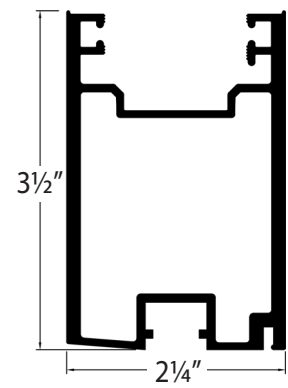
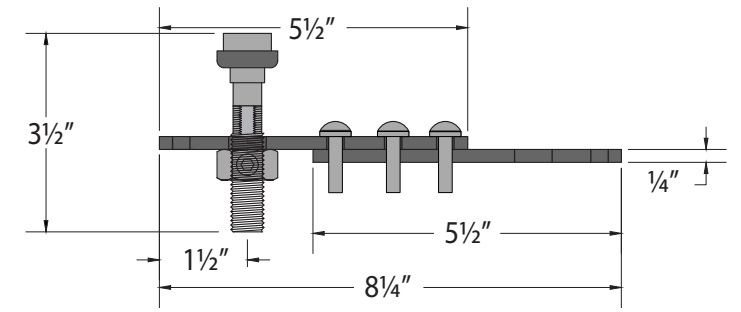

ACTIVE STILE

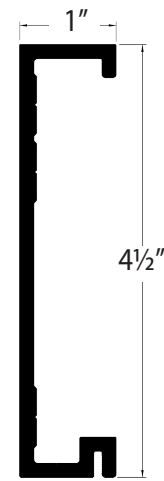
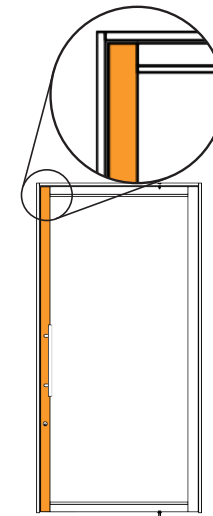

JAMB

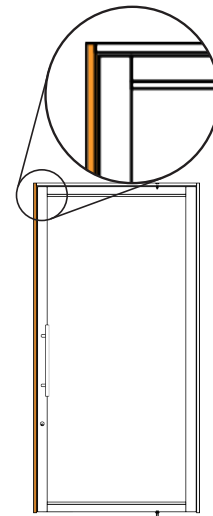

BOTTOM PIVOT PIN

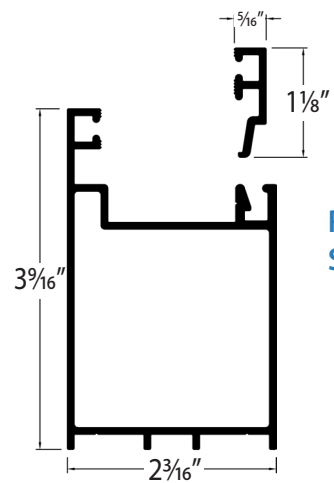
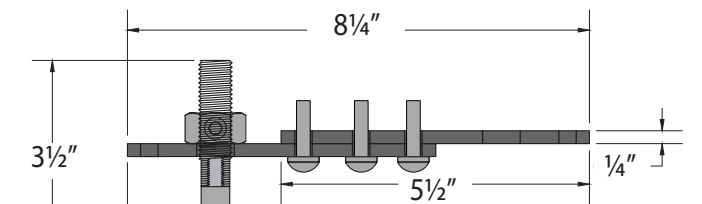

RAIL & SNAP BEAD

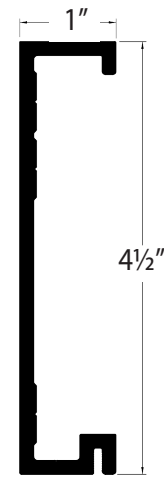
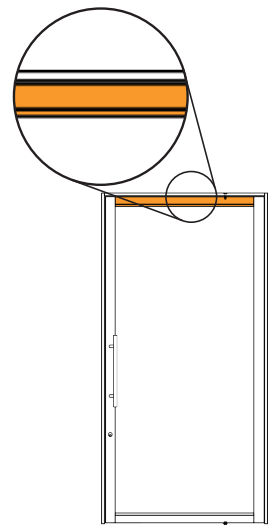

HEADER

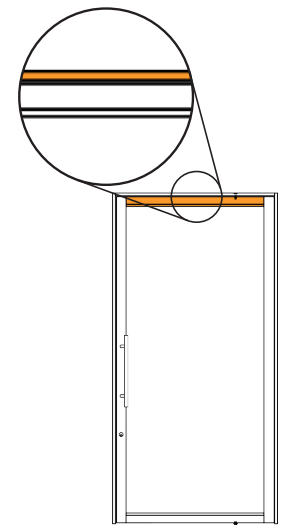

PIVOT CUP

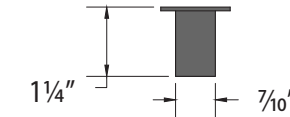

CHANNEL SILL

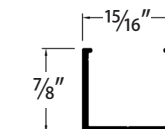

REDUCER BARS

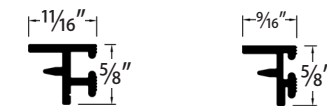

SWEEP COVER

